

High Performance Cold Air Intake Kit



INSTALLATION INSTRUCTIONS

S&B P/N 75-1530-1

**2002-2003
DODGE RAM 1500
5.9L GAS**

QTY PARTS LIST

- 1 1/2" x 24" Hose
- 1 4.5" - 2" Adapter
- 1 Intake Tube
- 1 Intake Box
- 1 Intake Scoop
- 1 Instruction Sheet
- 2 #72 Hose Clamps
- 1 Throttle Body Gasket

QTY PARTS LIST (continued)

- 1 S Bolt
- 1 1/4"-20 Nylock Nut
- 1 1/4" Fender Washer
- 1 Air Filter

TOOLS REQUIRED

- 13mm Wrench
- 7/16" Nut Driver or Socket
- Phillips & Flat Head Screw-driver

1. Turn off engine and disconnect negative battery terminal. Loosen clamps and remove stock air intake tube.



4. Slide on the 4.5x2 hose adaptor to the S&B cold air scoop



7. Remove the bolts that secure the OE throttle body. Be careful not to break the seal on the throttle body assembly

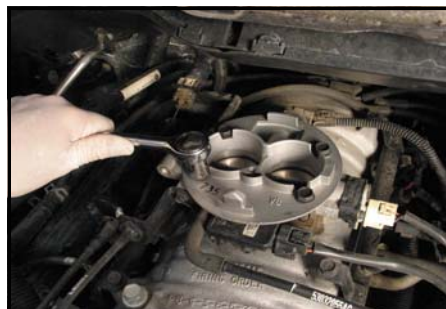

2. Remove the breather hose. Lift out the OE air box and remove the whole intake assembly as one piece

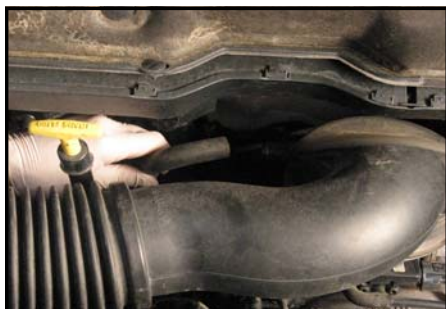

5. Install S&B Cold Air scoop onto the S&B cold air box



8. Remove the throttle body adaptor

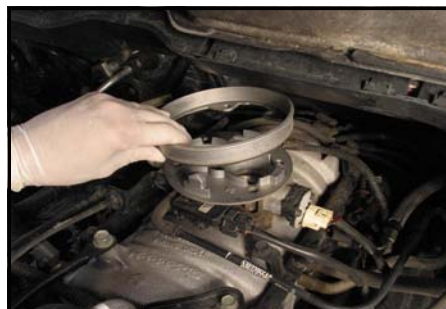

3. Assemble adapter ring to the S&B cold air box

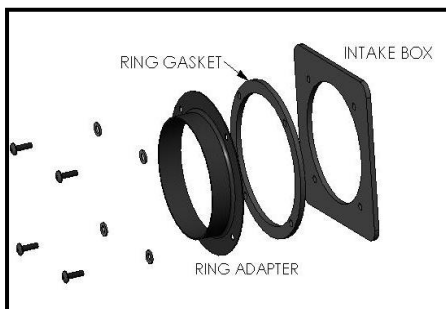

6. Install the S&B cold air scoop onto the S&B cold air box



9. Tighten the throttle body down using the same hardware

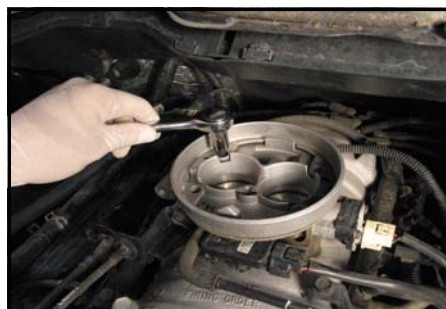

INSTALLATION INSTRUCTIONS (continued)

10. Place the gasket on the throttle body

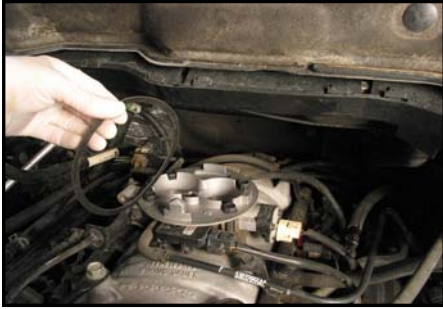

11. Install the stud provided into the tapped hole in the throttle body



12. Tighten the S&B cold air tube

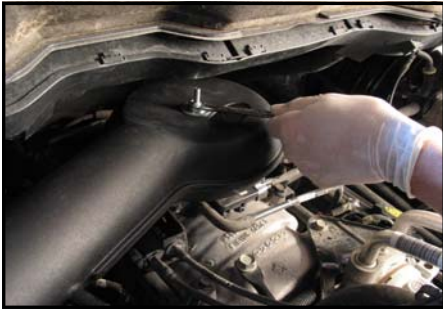

13. Make sure the S&B intake tube is properly seated on the throttle body.



14. Install the 1/2x24 breather hose provided



15. Install the S&B high performance air filter and re-connect the negative side of the battery. Installation is complete.



Smog Certification Note:

The California Air Resource Board (CARB) requires that an E.O. identification label be applied to the vehicle in order to pass a smog check inspection when a High Performance Intake Kit has been installed.

You must place the E.O. label provided on or near the intake kit after installation so that a smog check technician can easily verify the E.O. number.

PERFORMANCE TESTING

- * Engage parking brake and start your engine. To ensure that the system was installed properly, listen for abnormal noises. If an air leak is detected, re-inspect hoses and connections as they may need to be tightened.
- * S&B FILTERS RECOMMENDS THAT YOU KEEP YOUR OEM INTAKE SYSTEM IN THE EVENT IT IS REQUIRED IN THE FUTURE.
- * In order to maintain proper warranty, all connections and components must be checked periodically for realignment and to tighten all connections. Failure to do so will void your warranty.
- * Use only S&B cleaning and oil products to service your filter. Using other company's oil and cleaner products may void your warranty.

Please call (909) 947-0015 should you have any questions or comments.